

Molecular Coding Format manual

Akira Yamaji

May 5, 2021

Located at <http://www.ctan.org/pkg/mcf2graph>

Suggestion or request mail to: mcf2graph@gmail.com

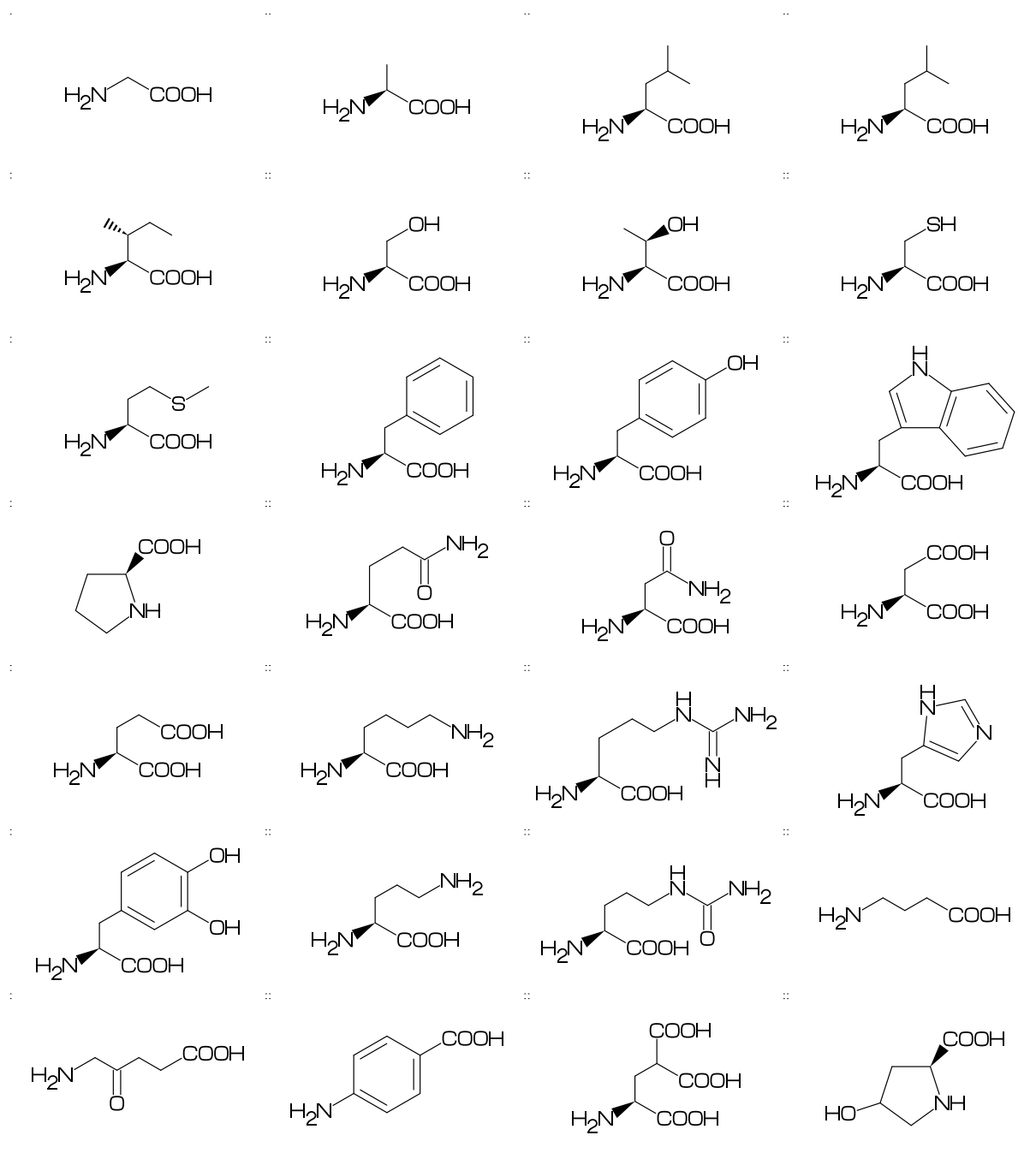

Contents

| | | |
|----------|---------------------------------|-----------|
| 1 | Introduction | 3 |
| 2 | MCF syntax | 3 |
| 2.1 | Make bond | 3 |
| 2.1.1 | Chain | 3 |
| 2.1.2 | Chain use !,ln | 3 |
| 2.1.3 | Jump to atom | 3 |
| 2.1.4 | Branch bond | 3 |
| 2.1.5 | Branch modified bond | 3 |
| 2.1.6 | Connect atom | 3 |
| 2.1.7 | Ring | 3 |
| 2.1.8 | Rotate current angle | 3 |
| 2.2 | Change bond type | 4 |
| 2.2.1 | Double,triple,wedge,vector | 4 |
| 2.2.2 | Change multiple bond type | 4 |
| 2.2.3 | Over line | 4 |
| 2.3 | Change bond length | 4 |
| 2.3.1 | Chain length | 4 |
| 2.3.2 | Ring length | 4 |
| 2.4 | Change atom | 4 |
| 2.4.1 | Insert atom | 4 |
| 2.4.2 | Addressed atom | 5 |
| 2.4.3 | Brock address | 5 |
| 2.4.4 | Reset brock address | 5 |
| 2.4.5 | Absolute address | 5 |
| 2.4.6 | Relative address | 5 |
| 2.4.7 | Charged atom | 5 |
| 2.5 | Fuse ring | 5 |
| 2.5.1 | Attached 1 bond | 5 |
| 2.5.2 | Attached 2 bond | 5 |
| 2.5.3 | Attached 3 bond | 6 |
| 2.5.4 | Attached 4 bond | 6 |
| 2.5.5 | Spiro ring | 6 |
| 2.6 | Group | 6 |
| 2.6.1 | Insert group | 6 |
| 2.6.2 | Insert modified group | 6 |
| 2.6.3 | Add group | 6 |
| 2.6.4 | Add modified group | 6 |
| 2.7 | Chain environment | 7 |
| 2.7.1 | Horizontal,vertical | 7 |
| 2.7.2 | Left-right,right-left | 7 |
| 2.7.3 | Fixed rotate angle | 7 |
| 2.7.4 | Multi rotate angle | 7 |
| 2.8 | Miscellaneous | 7 |
| 2.8.1 | Abbreviated parts | 7 |
| 2.8.2 | Parts definition | 7 |
| 2.8.3 | Parts inline definition | 7 |
| 2.8.4 | Move position | 7 |
| 2.8.5 | Change color | 8 |
| 2.8.6 | Change font | 8 |
| 3 | Option parameter | 8 |
| 3.1 | Angle parameter | 8 |
| 3.2 | Size/Ratio parameter | 8 |
| 3.2.1 | Bond length | 8 |
| 3.2.2 | Molecular size | 8 |
| 3.2.3 | Molecular position | 8 |
| 3.3 | Size parameter | 9 |
| 3.3.1 | Font size | 9 |
| 3.3.2 | Font margin | 9 |
| 3.3.3 | Offset thickness of bond | 9 |
| 3.3.4 | Offset of double bond gap | 9 |
| 3.3.5 | Offset of atom width | 9 |
| 3.3.6 | Offset of wedge width | 9 |
| 3.3.7 | Max bond length | 9 |
| 3.4 | Ratio parameter | 9 |
| 3.4.1 | Thickness/bond length | 9 |
| 3.4.2 | Char/bond thickness | 9 |
| 3.4.3 | Bond gap/bond length | 9 |
| 3.4.4 | Atom/bond length | 9 |
| 3.4.5 | Wedge/bond length | 9 |
| 3.4.6 | Font atom gap/atom length | 9 |
| 3.4.7 | Chain/ring length | 9 |
| 3.4.8 | Hash gap/bond length | 9 |
| 3.5 | Drawing mode | 10 |
| 3.5.1 | Numbering atom | 10 |
| 3.5.2 | Numbering bond | 10 |
| 3.5.3 | Trimming mode | 10 |
| 3.5.4 | Expand mode | 10 |
| 3.5.5 | Group off mode | 10 |
| 3.5.6 | Single bond mode | 10 |
| 3.6 | Frame | 10 |
| 3.6.1 | Font frame | 10 |
| 3.6.2 | Molecular frame | 10 |
| 3.6.3 | Atom frame | 10 |
| 3.7 | Parameter setting | 11 |
| 3.7.1 | Local parameter setting | 11 |
| 3.7.2 | Global parameter setting | 11 |
| 4 | Function | 11 |
| 4.1 | Function MC() | 11 |
| 4.2 | Function MCat() | 11 |
| 4.3 | Function check() | 11 |
| 4.4 | Function add() | 12 |
| 4.5 | Function ext() | 13 |
| 4.5.1 | Local ext() setting | 13 |
| 4.5.2 | Global ext() setting | 13 |
| 5 | MCF example | 14 |
| 5.1 | Luciferin | 14 |
| 5.2 | Colchicine | 14 |
| 5.3 | Paclitaxel | 14 |
| 5.4 | Lycorine | 14 |
| 5.5 | Gibberellin | 14 |
| 5.6 | Quinine | 14 |
| 6 | Example to use mcf2graph | 15 |
| 6.1 | Metafont/Metapost source file | 15 |
| 6.2 | Molecular data base file | 16 |
| 6.3 | Information aux file output | 17 |
| 6.4 | Metafont aux file output | 18 |
| 6.5 | MCF aux file output(1) | 19 |
| 6.6 | MCF aux file output(2) | 19 |
| 6.7 | Report output | 20 |
| 6.8 | MOL file output | 21 |
| 6.9 | LuaTeX file example | 22 |
| 6.10 | LaTeX file example | 23 |

1 Introduction

Molecular Coding Format(MCF) is new linear notation represent chemical structure diagrams. This Coding is named from programing technique such as operator, array, scope, macro, adressing, etc. mcf2graph convert from MCF to pk font, PNG, SVG, EPS, MOL file. It is also able to calculate molecular weight, exact mass, molecular formula.

2 MCF syntax

2.1 Make bond

2.1.1 Chain

real number plus (+): counterclockwise
real number minus(-): clockwise
\$n (0<=n<360): absolute angle

<10,-30,45,-45,60,\$300,\$0

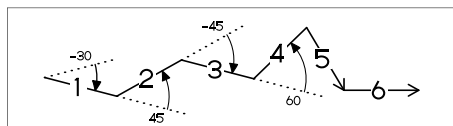

2.1.2 Chain use !,!n

! : take value 60 or -60 depend on current angle and environment
!6 : !,!,!,!,!,!

<-30,!6

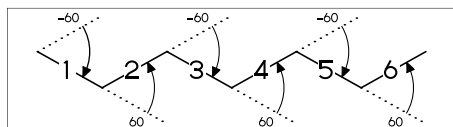

2.1.3 Jump to atom

@n : Jump to An
** An: atom number(-999<=n<=4095)

<-30,!6,@3,0,!,@5,-30

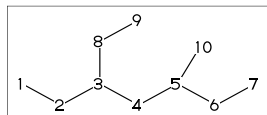

2.1.4 Branch bond

\ : 0

<-30,!6,@3,\,!

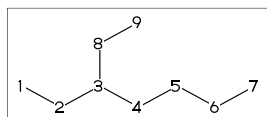

2.1.5 Branch modified bond

\ : 0
*\ : 0~wf
* : 0~zf
\ \ : 0~dm
** : 0~wv

<30,!8,
@2,\,!,@4,*\,!,@6,*,!,@8,\ \,!,@10,**,!

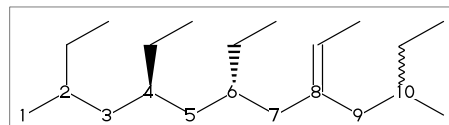

<30,!6,
\~dr,! : 0~dr,!
\'1.5,-90 : 0'1.5,-90
\^15,-60 : 0^15,-60

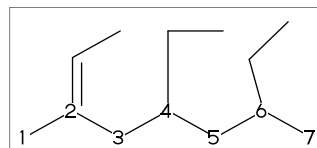

2.1.6 Connect atom

&n : Connect to An

<-30,!6,@3,\,!3,&6~bd,@9,&4~bz

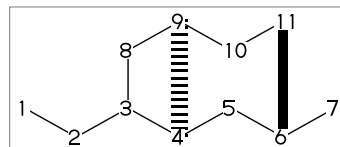

2.1.7 Ring

?n : n membered ring(3<=n<=20)
?6 : <-120,60,60,60,60,60,&1
?6

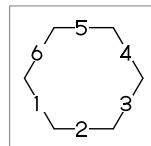

2.1.8 Rotate current angle

<angle : rotate current angle

0,0,<90,0,<-90,0,<\$315,0,<\$90,0,<\$0,0

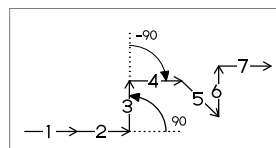

2.2 Change bond type

2.2.1 Double, triple, wedge, vector

(Double, triple)

a~type : ~type, a

dm : double middle

dl : double left side

dr : double right side

db : double left or right side

tm : triple

!! : !~db / !!! : !~tm

```
<-30,!~dm,!~dl,!~dr,!~db,!~tm
<-30,!~dm,!~dl,!~dr,!! ,!! ,!,!!!
```

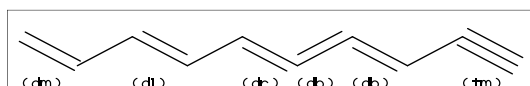

(Wedge)

wf: wedge forward

wb: wedge backward

zf: hashed(zebra stripe) wedge forward

zb: hashed(zebra stripe) wedge backward

```
<-30,!~wf,!~wb,!~zf,!~zb
```

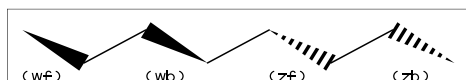

(Vector)

vf: vector forward

vb: vector backward

```
<-30,!~vf,!~vb
```



(Dotted, wave)

Bn=bond type : change bond type at Bn

dt : dotted

wv : wave

bd : broad

bz : broad dotted

```
<-30,!7,1=dt,3=wv,5=bd,7=bz
```



2.2.2 Change multiple bond type

```
{2,4,6}=dr : 2=dr,4=dr,6=dr
```

```
<30,!7,{2,4,6}=dr
```

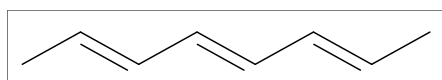

2.2.3 Over line

si_ : single over line

wf_ : wedge forward over line

wb_ : wedge backward over line

zf_ : hashed wedge forward over line

zb_ : hashed wedge backward over line

bd_ : broad over line

dl_ : duple left over line

dr_ : duple right over line

dm_ : duple over line

```
<30,!8,!60,90'18,
{2~si_,4~wf_,6~wb_,8~zf_,10~zb_,
 12~bd_,14~dl_,16~dr_,18~dm_}:/_ '2
```

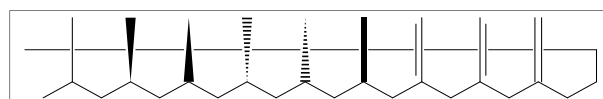

2.3 Change bond length

2.3.1 Chain length

(!,!n)'length : change length of !,!n

```
<-30,!2,!4'1.2,!2
```

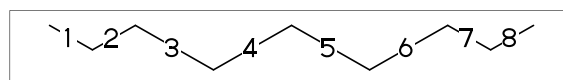

#n : bond length=n

: reset bond length

```
<-30,!2,#1.2,!4,##,!2
```

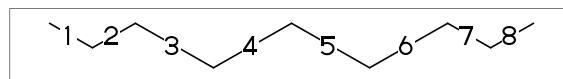

2.3.2 Ring length

?n'length : change ring length

```
?6,@4,\,?6'1.2
```

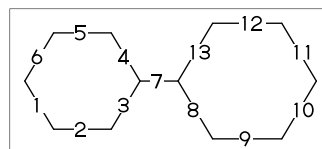

2.4 Change atom

2.4.1 Insert atom

Insert hetero atom

```
<-30,!2,0,!2,N,!2
```

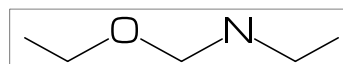

2.4.2 Addressed atom

2:0 : change A2 C to O
 {3,4}:N : change A3,A4 C to N

<30,14,2:0,{3,4}:N

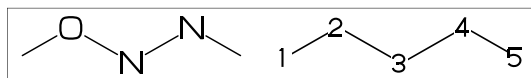

2.4.3 Brock address

| : divide brock

?6,@4,\,|,?6,2:0

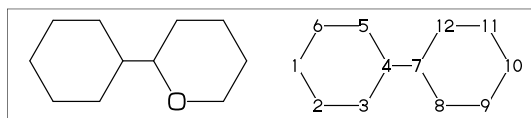

2.4.4 Reset brock address

|| : reset brock address

?6,@4,\,|,?6,||,2:N

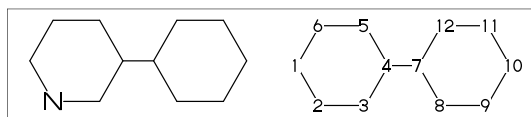

2.4.5 Absolute address

\$2:N : change A\$2 C to N **1<=n<=3095

?6,@4,\,|,?6,\$2:N

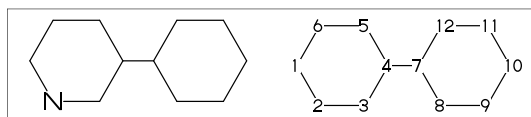

2.4.6 Relative address

-2:N : change A(-2) C to N ** -999<=n<=-1

?6,@4,\,?6,-2:N

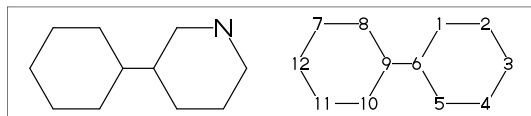

2.4.7 Charged atom

p_ : positive / n_ : negative

<-30,!2,N,??,p_,!2,S,n^180,
 !6,7:N,7:??,9:S,7:n_,9:n_^180

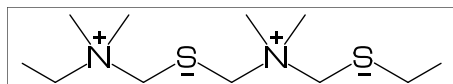

2.5 Fuse ring

2.5.1 Attached 1 bond

?6,3=?6 : fuse ?6 at B3

** Bn(n:-999<=n<=4095): bond number

?6,3=?6

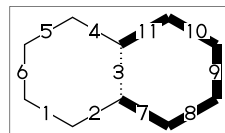

** fused ring size depend on attached bond length

?6,@4,\,?6'1.2,5=?6,11=?6

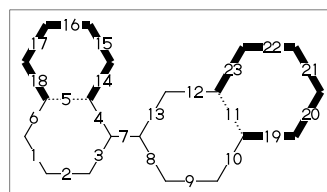

?6,3=?6[13] : fuse ?6[13] at B3

?6[13]: 6 membered ring scaled 13/10

** ?m[n] (5<=m<=8,11<=n<=15)

?6,3=?6[13]

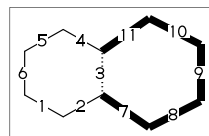

?6,{-3,-4,-4,-2,-2,-4,-4}=?6

?6,{4,8,13,20,25,28,33}=?6

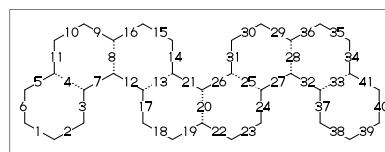

2.5.2 Attached 2 bond

(4,11)=?6[4] : fuse 4/6 ring to B11..B4

(4,11)=?5[3] : fuse 3/5 ring to B11..B4

(4,11)=?4[2] : fuse 2/4 ring to B11..B4

** ?m[n] (4<=m<=6,n=m-2)

1:<30,?6,3=?6,(11,4)=?6[4]

2:<30,?6,3=?6,(11,4)=?5[3]

3:<30,?6,3=?6,(11,4)=?4[2]

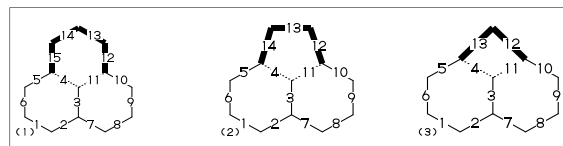

2.5.3 Attached 3 bond

(16,4)=?6[3] : fuse 3/6 ring to B16..B4
 (16,4)=?5[2] : fuse 2/5 ring to B16..B4
 ** ?m[n] (5<=m<=6,n=m-3)

1:?6,{3,10}=?6,(16,4)=?6[3]
 2:?6,{3,10}=?6,(16,4)=?5[2]

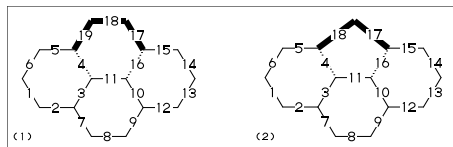

2.5.4 Attached 4 bond

(21,4)=?6[2] : fuse 2/6 ring to B21..B4

MC(<-30,?6,{3,10,15}=?6,(21,4)=?6[2])

** ?m[n] (m=6,n=2)

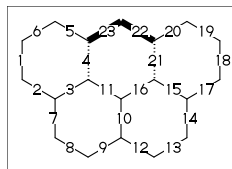

2.5.5 Spiro ring

@4,?5 : add ?5 at A4

<30,!6,@4,?5

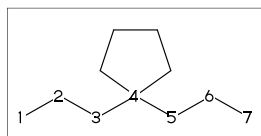

2.6 Group

2.6.1 Insert group

/ : single

<-30,!/,!,!,/!,!3,/!2,!,/?!,
 !3,/??!,!,/Ph^-30,!)

** /_ : methyl /! : ethyl
 /!2 : propyl /?! : isopropyl
 /??! : tert-butyl /Ph : phenyl

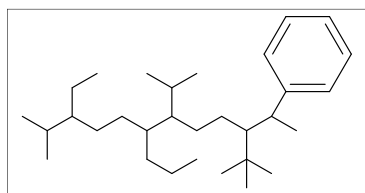

2.6.2 Insert modified group

// : double (double middle)

*/ : wedge forward

/* : hashed wedge forward

/ : wave

** : direct

<30,!/,!/0,!2,*/H,!2,/*H,!2,*/*H,!2,**?3,!)

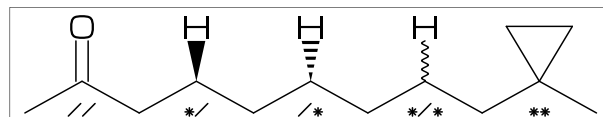

~ : change type

^ : change angle

' : change length

> : change environment

<-30,'^1,!,
 /_'^2^30,!2,/!2>lr,!2,/!2>r1,!)

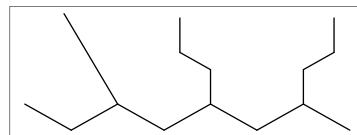

2.6.3 Add group

<30,!17,2:/_,4:/!,6:/!2,
 10:/?! ,14:/??!,16:/Ph^-60

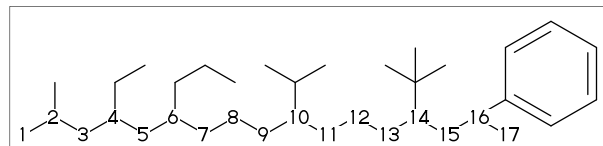

2.6.4 Add modified group

~,^,' : change type,angle,length

<30,!6,{2~wf,4~zf,6^-30,8^\$120}:/_

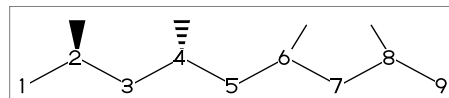

^,',> : change angle,length,environment

<-30,!7^1,3:/_'^2^30,5:/!2>lr,7:/!2>r1

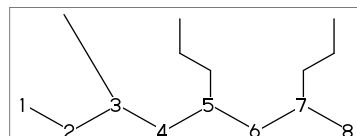

2.7 Chain environment

2.7.1 Horizontal,vertical

>hz : horizontal environment (default)
>vt : vertical environment

```
?4,  
{3^-90,3^-30,3^90}:/'(!3,"{hz}")>hz,  
{1^-60,1,1^60}:/'(!3,"{vt}")>vt
```

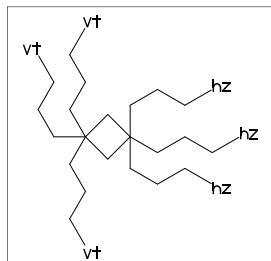

2.7.2 Left-right,right-left

>lr : left-right environment
>rl : right-left environment

```
<-30,!6,  
{3^-30,3,3^30}:/'(!3,"{lr}")>lr,  
{5^-30,5,5^30}:/'(!3,"{rl}")>rl
```

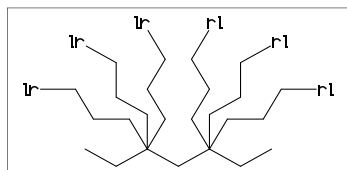

2.7.3 Fixed rotate angle

>n : rotate n

```
<30,!4,  
2:/!6>30, % 2:\,30,30,30,30,30,30  
4:/!4>-45 % 4:\,-45,-45,-45,-45
```

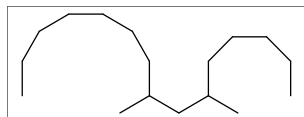

2.7.4 Multi rotate angle

>'(90,-90,...) : rotate 90,-90,...

```
<30,!6,6>'(90,-90,90,-90,90):/!5
```

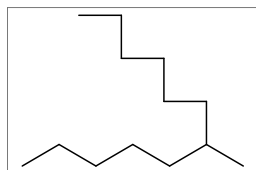

2.8 Miscellaneous

2.8.1 Abbreviated parts

```
NH : N,/H~n1  
N! : N,/_  
N!2 : N,/!  
S0 : S,//0  
S00 : S,//0^35,/^-35
```

```
<-30,!2,NH,!2,N!,!2,N!2,S0,!2,S00,!
```

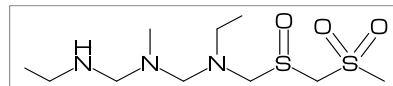

```
?! : /_,!  
?? : /_^35,/_-35  
/?! : isopropyl  
/??? : tert-butyl  
/N?! : dimethylamino
```

```
<30,!9'1,?!,!2,??,!2,  
2:??,4:/??,6:/???!,8:/N?!
```

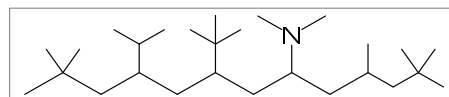

2.8.2 Parts definition

'(..) : user defined parts

```
iBuOH:= '(!,/_,! ,OH);  
MC(<30,?6,{4,6}:/iBuOH)
```

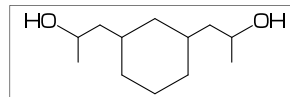

2.8.3 Parts inline definition

```
<30,! , /'(!,/_,! ,OH),!
```

```
<30,!8,{2,6}:/'(!,/_,! ,OH)
```

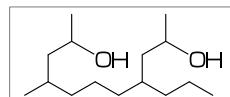

2.8.4 Move position

@(x,y) : Move to (l*x,l*y) from origin
** l=bond length of ring

```
<30,?6,@3,!4,//0,! ,0,n_^60,@(6,1),H,p_^15
```

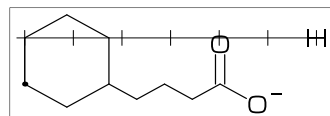

2.8.5 Change color

(use with metapost only)

```
beginfont()
  MC(<30,Ph,{2,5}:N,3:/NH2,4:/COOH,
    %-----
    2:red,      % red   A2
    5:blue,     % blue  A5
    3:green,    % green B3
    %-----
  )
endfont
```

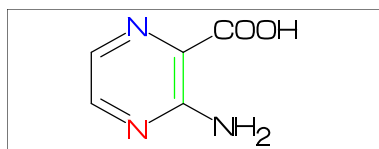

2.8.6 Change font

(use with metapost only)

```
beginfont()
  %-----
  atomfont:="cmr8";
  %-----
  MC(<30,Ph,{2,5}:N,3:/NH2,4:/COOH)
endfont
```

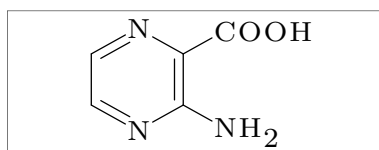

3 Option parameter

3.1 Angle parameter

mangle=0 ** default

MCat(0.2,0.5)(Ph)

mangle:=30;

MCat(0.8,0.5)(Ph)

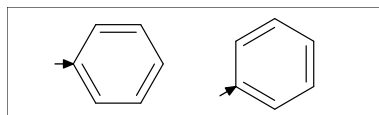

3.2 Size/Ratio parameter

3.2.1 Bond length

(fit to font size)

blength=0 ** default

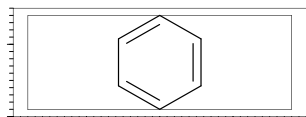

(ratio bond/font width)

blength=0.1 ** (0<blength<=1)

blength=60mm(width)*0.1=6mm

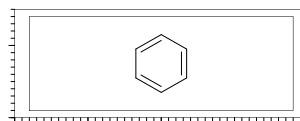

(bond length)

blength=9mm

** (blength>1) ignore msize(w,h)

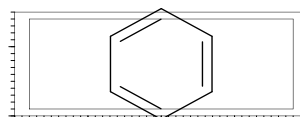

3.2.2 Molecular size

msize=(1,1) ** default

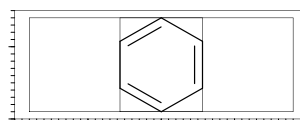

msize=(0.25,1)

msize=40mm-4mm*0.25=9mm

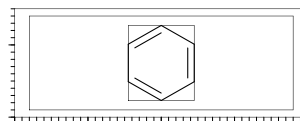

msize=(11mm,11mm)

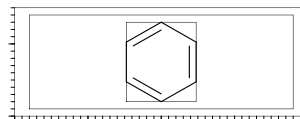

3.2.3 Molecular position

mposition=(0.5,0.5) ** default

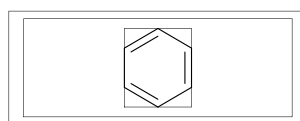

mposition=(1,0)



mposition=(10mm,4mm)

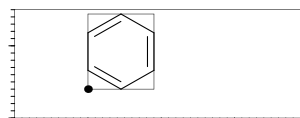

3.3 Size parameter

3.3.1 Font size

fsize=(font width,font height)
** default: (30mm,20mm)

fsize=(40mm,15mm)

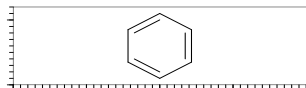

3.3.2 Font margin

fmargin=(margin left right,top bottom)
** default: (0.4mm,0.4mm)

fmargin=(10mm,2mm)

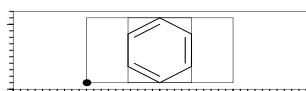

3.3.3 Offset thickness of bond

default: offset_thickness=0.2pt

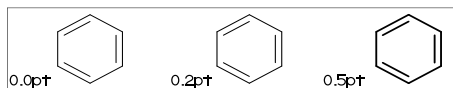

3.3.4 Offset of double bond gap

default: offset_bond_gap=0.3pt

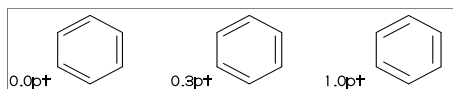

3.3.5 Offset of atom width

default: offset_atom=0.8pt

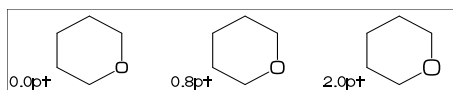

3.3.6 Offset of wedge width

default: offset_wedge=0.4pt

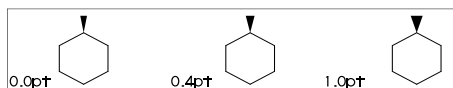

3.3.7 Max bond length

default: max_blength=10mm

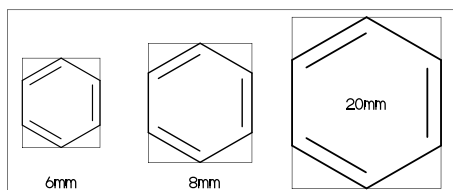

3.4 Ratio parameter

3.4.1 Thickness/bond length

default: ratio_thickness_bond=0.015

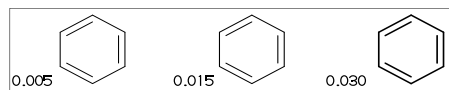

3.4.2 Char/bond thickness

default: ratio_char_bond=1.5

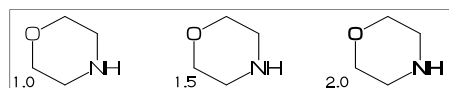

3.4.3 Bond gap/bond length

default: ratio_bondgap_bond= 0.15

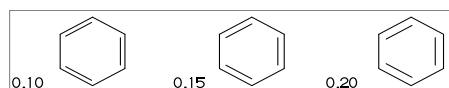

3.4.4 Atom/bond length

default: ratio_atom_bond= 0.36

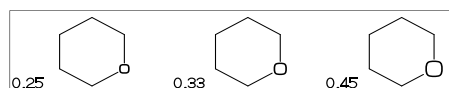

3.4.5 Wedge/bond length

default: ratio_wedge_bond=0.12

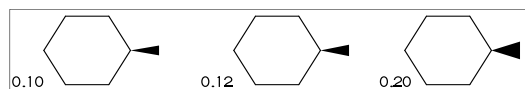

3.4.6 Font atom gap/atom length

default: ratio_atomgap_atom= 0.050

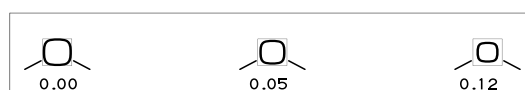

3.4.7 Chain/ring length

default: ratio_chain_ring= 0.66

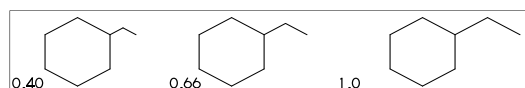

3.4.8 Hash gap/bond length

default: ratio_hashgap_bond=0.12

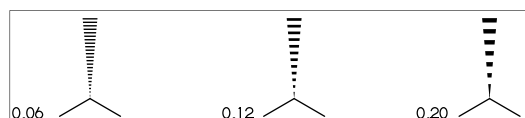

3.5 Drawing mode

3.5.1 Numbering atom

```
numberA_start:=3; numberA_end:=8;  
default: sw_numberA=0 :  
  numberA_start=1 numberA_end=4095
```

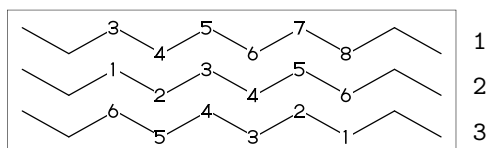

3.5.2 Numbering bond

```
numberB_start:=3; numberB_end:=8;  
default: sw_numberB=0 :  
  numberB_start=1 numberB_end=4095
```

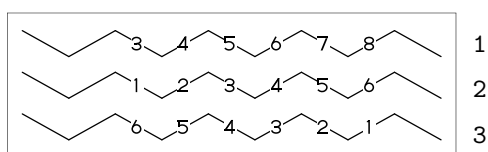

3.5.3 Trimming mode

```
sw_trimming:=0; ** default  
msize:=(1,0.7);  
MCat(0.2,0.3)(Ph)  
MCat(0.8,0.7)(Ph)
```

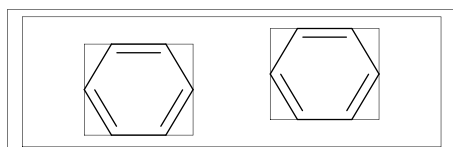

```
sw_trimming:=1;  
MCat(0.2,0.3)(Ph)  
MCat(0.8,0.7)(Ph)
```

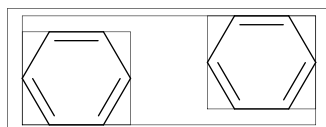

3.5.4 Expand mode

```
MCat(0, .5)(<30,Ph,4:/COOH,3:/NH2)  
sw_expand:=1;  
MCat(1, .5)(<30,Ph,4:/COOH,3:/NH2)  
** default: sw_expand=0
```

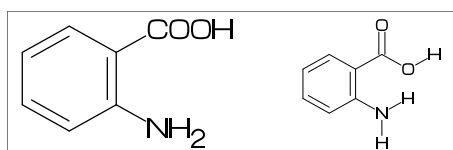

3.5.5 Group off mode

```
** default: sw_group_off=0
```



3.5.6 Single bond mode

```
** default: sw_single=0
```



3.6 Frame

3.6.1 Font frame

```
** default:sw_fframe=0  
(Draw font frame)  
fmargin:=(5mm,2mm);  
sw_fframe=1
```

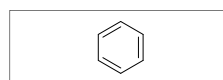

```
(Frame inside margin)  
sw_fframe=2
```

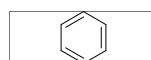

```
(Draw both frame)  
sw_fframe=3
```

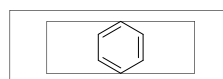

3.6.2 Molecular frame

```
sw_mframe=1  
** default:sw_mframe=0
```

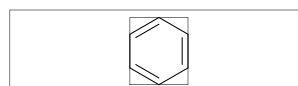

3.6.3 Atom frame

```
sw_iframe=1  
** default: sw_iframe=0
```

```
MC(<30,COOH,!,COOH)
```

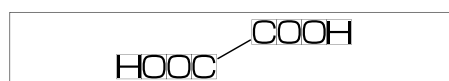

3.7 Parameter setting

3.7.1 Local parameter setting

```
beginfont()
  MC(Ph)
endfont
beginfont()
  %-----
  ratio_thickness_bond:=0.05;
  %-----
  MC(Ph)
endfont
beginfont()
  MC(Ph)
endfont
```

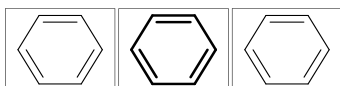

3.7.2 Global parameter setting

```
beginfont()
  MC(Ph)
endfont
%-----
ratio_thickness_bond:=0.05;
%-----
beginfont()
  MC(Ph)
endfont
beginfont()
  MC(Ph)
endfont
```

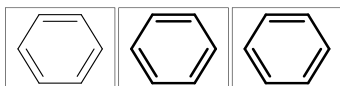

4 Function

4.1 Function MC()

(Draw molecule)

```
msize=(a,b)      **default (1,1)
mposition=(c,d)  **default (0.5,0.5)
```

a: ratio molecular width/font width
b: ratio molecular height/font height
c: x axis position
d: y axis position

```
beginfont()
  MC(<30,Ph,3:/F,4:/Cl)
endfont
```

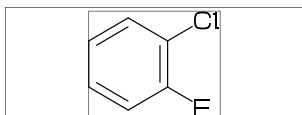

4.2 Function MCat()

(Draw molecule at mposition)

MCat(c,d)(....) :

mposition:=(c,d); MC(....)

c: x axis position
d: y axis position

```
defaultsize:=5bp;
fsize:=(60mm,40mm); fmargin:=(3mm,3mm);
blength:=0.07; sw_fframe:=1;
mangle:=0;
for i=1 step -0.5 until 0:
  for j=0 step 0.33 until 1:
    MCat(j,i)(Ph,4:N)
    add(drawarrow((A1+A1up**aw)..A1);
        label(decimal(mangle),
            p0+(0.5w,0.5h));
    )
    mangle:=mangle+30;
  endfor
endfor
```

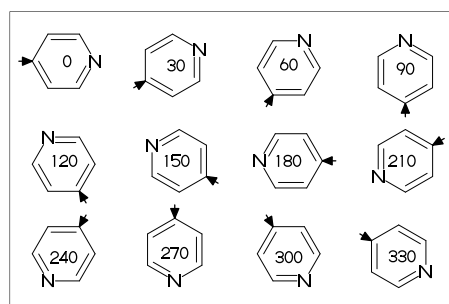

4.3 Function check()

(immediately compile)

```
beginfont("EN:Pyridine")
  MC(<30,Ph,2:N)
endfont
```

(check mcf and compile)

** check(mc) : error count

```
beginfont("EN:Pyridine",
  " :<30,Ph,}2:N" ) % ** extra '}'
  if check(mc)=0: MC(scantokens(mc)) fi
endfont
```



check(mc)=0 check(mc)>=1

4.4 Function add()

(Add label to molecule)

w: molecular width
 h: molecular height
 aw: atom font size
 em: label font size
 p0: origin of molecular structure
 l: bond length

An: atom number
 A[m]: atom position
 A[m]ang: branch angle of A[m]
 A[m]up: dir A[m]ang
 A[m]left: dir A[m]ang+90
 A[m]right: dir A[m]ang-90
 A[m]down: dir A[m]ang+180

Bn: bond number
 B[m]: bond(path)
 B[m]s: bond start position
 B[m]m: bond middle position
 B[m]e: bond end position
 B[m]ang: bond angle
 B[m]up: dir B[m]ang
 B[m]left: dir B[m]ang+90
 B[m]right: dir B[m]ang-90
 B[m]down: dir B[m]ang+180

plus : '+' circled
 minus : '-' circled
 circlediam = 0.6aw (default)
 circlepen = 0.2bp (default)

lonpair r: ':' rotated r
 lonpairdiam = 0.3aw (default)
 lonpairspace = 0.7aw (default)

** : scaled
 << : rotated
 a /* b : point b of a

```
beginfont("EN:add() 1")
  fontsize=(70mm,40mm);
  sw_aframe:=sw_mframe:=1;
  max_blength:=10mm;
  msiz=(.91,.9);
  MCat(.5,.85)(<30,?6,{2,5}:0)
  add(
    defaultscale:=.8;
    labeloffset:=.3aw;
    dotlabel.lft("p0",p0);
    dotlabel.rft("p0+(w,h)",p0+(w,h));
    dotlabel.ulft("A1",A1);
    drawarrow A1..A1+__*l<<A1ang;
    dotlabel.lrt("B3s",B3s);
    dotlabel.rft("B3m",B3m);
    drawarrow B3m..B3m+__*l<<(B3ang+90);
    dotlabel.ulft("A6",A6);
```

```
drawarrow A1{A1down}..A6;
dotlabel.urt("B3e",B3e);
label.rft("An="&decimal(An)&
  " Bn="&decimal(Bn)&
  " aw="&decimal(aw)&
  " em="&decimal(em),
  p0+(-9em,-1.5em));
label.rft("w="&decimal(w)&
  " h="&decimal(h)&
  " l="&decimal(l),
  p0+(-9em,-3em));
)
endfont
```

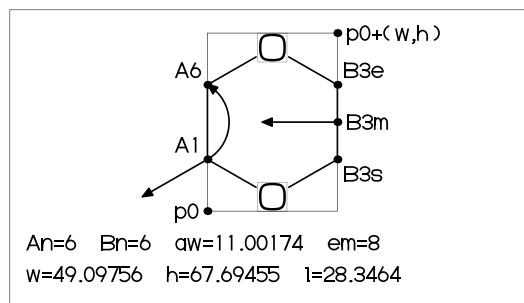

```
beginfont("EN:add() 2")
  fontsize=(60mm,20mm);
  msiz=(1,0.85);
  %-----
  MCat(0,0)(<30,Ph,3=d1,4:/NH2)
  %-----
  add(
    labeloffset:=.7aw;
    label.top(lonpair 90,A7);
    drawarrow
      (A7+up**1.2aw){A7left}
      ..{B7right}B7/*0.3;
    drawarrow
      B3m..A3+B2up**1.5aw..{A3down}A3;
  )
  %-----
  MCat(1,0)(<30,?6,{1,5}=d1,4://NH2)
  %-----
  add(
    labeloffset:=.7aw;
    label.top(plus,A7);
    label.urt(minus,A3);
    label(lonpair A3ang,A3+A3up**0.7aw);
  )
  %-----
  ext(drawdblarrow (.4w,.4h)..(.55w,.4h));
  %-----
endfont
```

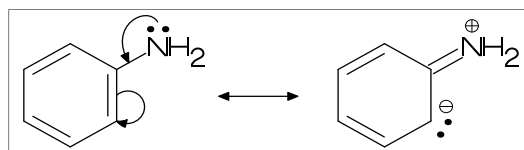

4.5 Function ext()

(Extra label to font)

```
w:      font width
h:      font height
w0:     font width-2xpart(fmargn)
h0:     font height-2ypart(fmargn)
aw:     atom font size
em:     label font size
p0:     fmargn

n:      molecular number
p[m]:   molecular origin position
w[m]:   molecular width
h[m]:   molecular height

ratio_thickness_char:
pen thickness / char width
%-----
beginfont()
  fontsize=(70mm,30mm);
  blength:=0.065;
%-----
MCat(0.1,0.5)(
  <-210,60'1,60'1,60'1,{1,3}=d1,
  1:/R1,4:/R2^-60
)
  add(
    defaultscale:=0.6;
    label.bot("Diene",p0+(0.5w,0));
  )
MCat(0.4,0.5)(
  <-30,-60'1,1=d1,1:/R3,2:/R4^60)
  add(defaultscale:=0.6;
  label.bot("Dienophile",p0+(.5w,0));
)
MCat(0.9,0.5)(
  <30,?6,6=d1,2:/R2,3:/R4,4:/R3,5:/R1
)
%-----
ext(
  drawarrow (.52w,.5h)..(.6w,.5h);
  defaultscale:=0.7;
  label("+", (0.25w,0.5h));
  ratio_thickness_char:=0.125;
  label.bot("Diels-Alder Reaction",
    (.5w,h));
)
%-----
endfont
```

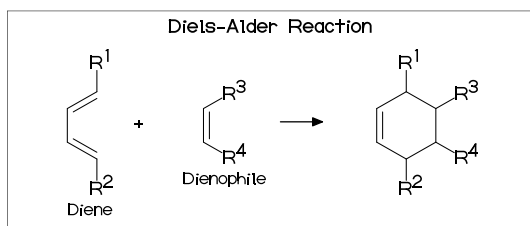

4.5.1 Local ext() setting

```
beginfont("EN:?3")
  fontsize=(12mm,15mm);
  MCat(0.5,1)(<30,?3)
endfont
beginfont("EN:?4")
  fontsize=(12mm,15mm);
  MCat(0.5,1)(?4)
%-----
ext(label.top(inf_EN,(0.5w,0));)
%-----
endfont
beginfont("EN:?5")
  fontsize=(12mm,15mm);
  MCat(0.5,1)(?5)
endfont
beginfont("EN:?5")
  fontsize=(12mm,15mm);
  MCat(0.5,1)(?6)
endfont
```

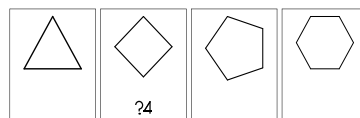

4.5.2 Global ext() setting

ext_clear: reset global ext()

```
beginfont("EN:?3")
  fontsize=(12mm,15mm);
  MCat(0.5,1)(<30,?3)
endfont
%-----
ext(label.top(inf_EN,(0.5w,0));)
%-----
beginfont("EN:?4")
  fontsize=(12mm,15mm);
  MCat(0.5,1)(?4)
endfont
beginfont("EN:?5")
  fontsize=(12mm,15mm);
  MCat(0.5,1)(?5)
endfont
%-----
ext_clear;
%-----
beginfont("EN:?6")
  fontsize=(12mm,15mm);
  MCat(0.5,1)(?6)
endfont
```

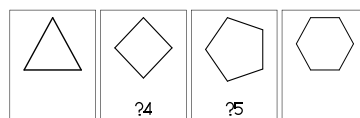

5 MCF example

5.1 Luciferin

```
(use data base file 'mcf_data_base')
beginfont("f:mcf_data_base",
          "t:EN", "v:Luciferin")
  fsize:=(50mm,15mm);
  if check(mc)=0: MC(scantokens(mc)) fi
endfont
```

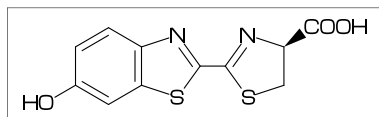

5.2 Colchicine

```
beginfont("EN:Colchicine", "MW:385.41",
          %-----
          ": <30,Ph,{1,2,6}:/O!,-4=?7,-5=?7, ",
          ": {-1,-4,-6}=d1,-2://0,-3:/O!, ",
          ": @9,\,NH,!,//0,! ")
          %-----
  fsize:=(50mm,20mm);
  if check(mc)=0: MC(scantokens(mc)) fi
endfont
```

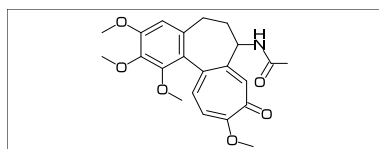

5.3 Paclitaxel

```
beginfont("EN:Paclitaxel", "MW:853.91",
          %-----
          ": ?6,5=d1,@3,#1,36,45,45,45,45,##, ",
          ": &5",
          ": -4=?6,-4=?4,-1=wb,-3=wf,-1:0,||, ",
          ": 4:??,6:/_{3~-60,15}:*/OH, ",
          ": 8:/*H^-60,",
          ": 9:*/_ ^60,10://0, ",
          ": @1,\,0,!,//0,!,*OH,!,/Ph,60~wf, ",
          ": NH,-60,//0,60,Ph, ",
          ": @7,\*,0,-45,//0,60,Ph, ",
          ": @11,\*,0,-60,//0,60, ",
          ": @12,\*^-15,0,60,//0,-60 ")
          %-----
  fsize:=(50mm,25mm);
  if check(mc)=0: MC(scantokens(mc)) fi
endfont
```

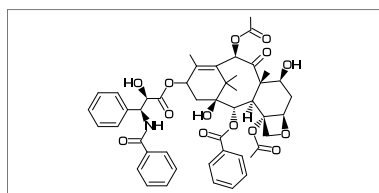

5.4 Lycorine

```
beginfont("EN:Lycorine", "MW:287.31",
          %-----
          ": Ph,-4=?6,-2=?6,6=?5,(9,12)=?5[3], ",
          ": 13=d1,8:N,{15,17}:0, ",
          ": 9:/*H^180,10:*/H^60, ",
          ": 13:*/OH,14:/*OH ")
          %-----
  fsize:=(50mm,20mm);
  if check(mc)=0: MC(scantokens(mc)) fi
endfont
```

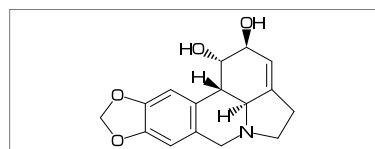

5.5 Gibberellin

```
beginfont("EN:Gibberellin A3", "MW:346.37",
          %-----
          ": <18,?5,3=?7,5=?6[12],@8,160'1.3,&3, ",
          ": 13=d1,6=wf,8=wb, ",
          ": @5,40~zf'1,0,50,//0^180,&14~zb, ",
          ": 2:/COOH,7://_,13:*/OH,8:/*OH, ",
          ": 14:*/_{1,4}:*/H^60 ")
          %-----
  fsize:=(50mm,18mm);
  if check(mc)=0: MC(scantokens(mc)) fi
endfont
```

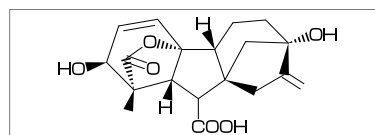

5.6 Quinine

```
beginfont("EN:Quinine", "MW:324.42",
          %-----
          ": <30,Ph,3=Ph,7:N,6:/O!, ",
          ": @10,\,*OH,/H~zf^-60,! ",
          ": |,?6,2:N,1:*/H^60,4:*/!! ",
          ": @2,165~zf,60,&5~zb ")
          %-----
  fsize:=(50mm,20mm);
  if check(mc)=0: MC(scantokens(mc)) fi
endfont
```

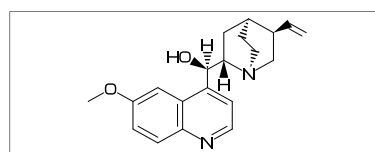

6 Example to use mcf2graph

6.1 Metafont/Metapost source file

```
%-----
input mcf2graph.mf;                                > input main macro
%-----
sw_output:=Info1;      % aux(information) file output on > global setting
%% sw_output:=Report;  > report output
%% sw_output:=MOL2k;   > MOL file output
fsize:=(60mm,40mm);   % (font width,font height)       >
tag1:="J";            > jobname
tag2:="C";            > char No
tag3:="mw";           % calculated molecular weight      >
tag4:="fm";           % calculated molecular formula     >
outputformat:="png"; hppp:=vppp:=0.1;                > PNG output
outputtemplate:="%j-%3c.png";                       >
%-----
beginfont("EN:Ampicillin","MW:349.405")              > information
  MC(<45,?4,-3=?5,2:N,7:S,                            > immediately compile
    3^45:/*H,1://O^15,5:/*COOH^-18,6:??,              >
    @4,*\^15,NH,!,//O,!/*NH2,! ,Ph)                  >
endfont                                               >
%-----
beginfont("EN:Cholesterol","MW:386.65",              >information
  %-----
  ": <30,?6,{-4,-2}?6,-4=?5,7=d1,                    ", > mc1
  ": 10:/*H^180,11:/*H^-60,17:/*H^-54,              ", > mc2
  ": {4,12}:*/_^60,                                   ", > mc3
  ": @-1,18,/*_,-60,!3,?!                            ") > mc4
  %-----
  if check(mc)=0: MC(scantokens(mc)) fi                > mc=mc1 - mc4
endfont                                               >
%-----
beginfont("f:mcf_data_base","t:EN","v:Adenine")      > from mcf_data_base.mcf
  if check(mc)=0: MC(scantokens(mc)) fi                > select EN="Adenine"
endfont                                               >
%-----
beginfont("f:mcf_data_base","t:EN","v:Guanine")      > from mcf_data_base.mcf
  if check(mc)=0: MC(scantokens(mc)) fi                > select EN="Guanine"
endfont                                               >
%-----
beginfont("f:mcf_data_base","t:EN","v:Cytosine")     > from mcf_data_base.mcf
  if check(mc)=0: MC(scantokens(mc)) fi                > select EN="Cytosine"
endfont                                               >
%-----
beginfont("f+:mcf_data_base","t:n","v:4")            > from mcf_data_base.mcf
  if check(mc)=0: MC(scantokens(mc)) fi                > v:4 select No.4
endfont                                               > 'f+' keep file open
%-----
for i=5 upto 155:                                     > from mcf_data_base.mcf
  beginfont("f+:mcf_data_base","v:*")                  > v:* no selection
  if check(mc)=0: MC(scantokens(mc)) fi                > No.5 - No.155
  endfont                                              > 'f+' keep file open
endfor                                               >
%-----
bye
```

6.2 Molecular data base file

```
%%%%%%%%%%%%%%%%%%%%%%%%%%%%%%%%%%%%%%%%%%%%%%%%%%%%%%%%%%%%%%%%%%%%%%%%%
% molecular data base file mcf_data_base.mcf by Akira Yamaji 2021.04.18
%%%%%%%%%%%%%%%%%%%%%%%%%%%%%%%%%%%%%%%%%%%%%%%%%%%%%%%%%%%%%%%%%%%%%%%%%
% tag1:var1;tag2:var2;tag3:var3 ....
% first character of line '%' comment out
% first character of line '+' begin MCF , end MCF
%-----
Cat:biological;EN:Adenine;MW:135.13
+
<30,?6,3=?5,{1,3,5,9}=d1,{2,6,9}:N,5:/NH2,7:NH
+-----
Cat:biological;EN:Guanine;MW:151.13
+
<30,?6,3=?5,{1,3,9}=d1,{2,9}:N,{6,7}:NH,5://0,1:/NH2
+-----
Cat:biological;EN:Cytosine;MW:111.10
+
<30,?6,{4,6}=d1,4:N,3://0,2:NH,5:/NH2
+-----
Cat:biological;EN:Thymine;MW:126.11
+
<30,?6,3=d1,{2,6}:NH,{1,5}://0,4:/_
+-----
Cat:biological;EN:Uracil;MW:112.09
+
<30,?6,6=d1,{3,5}://0,{2,4}:NH
+-----
Cat:biological;EN:Geraniol;MW:154.25
+
<30,!8,OH,{2,6}=dr,{2,6}:/_
+-----
Cat:biological;EN:Limonene;MW:136.24
+
<30,?6,2=d1,2:/_,@5,*\,/_,!!
+-----
Cat:biological;EN:l-Menthol;MW:156.27
+
<30,?6,2:/*?!,5:*/_ ,3:*/OH
+-----
Cat:biological;EN:Vanillin;MW:152.15
+
<30,Ph,2:/OH,3:/O!,5:/CHO
+-----
Cat:biological;EN:Allicin;MW:162.28
+
<-30,!! ,!2,S0,! ,S,!2,!!
+-----
Cat:biological;EN:Stearic acid;MW:284.48
+
<30,!17,COOH
+-----
Cat:biological;EN:Linoleic acid;MW:280.45
+
<30,!5,-30,-30,! ,-30,-30,!7,COOH,{6,9}=dr
+-----
```

6.3 Information aux file output

(Insert option parameter setting)

```
sw_output:=Info1;    % tag1:var1;tag2:var2
sw_output:=Info2;    % tag1;tag2 var1;var2
sw_output:=Info_t;  % tag1:var1;tag2:var2 / output 'temp-info.aux'
```

(Command line)

```
>mpost -s ahlength=1 FILENAME (sw_output=Info1)
>mpost -s ahlength=2 FILENAME (sw_output=Info2)
```

(Source)

```
beginfont("EN:Ampicillin")    .... endfont
beginfont("EN:Cholesterol")   .... endfont
beginfont("EN:Limonin")       .... endfont
beginfont("EN:beta-Carotene") .... endfont
```

(Setting)

```
tag1:="J"; tag2:="C"; tag3:="mw"; tag4:="fm"; tag5:="EN";
```

(Output)

(sw_output=Info1)

```
F:mcf_man_soc;C:1;mw:349.40462;fm:C16H19N3O4S;EN:Ampicillin
F:mcf_man_soc;C:2;mw:386.6532;fm:C27H46O;EN:Cholesterol
F:mcf_exa_soc;C:3;mw:470.5113;fm:C26H30O8;EN:Limonin
F:mcf_exa_soc;C:4;mw:536.8722;fm:C40H56;EN:beta-Carotene
```

(sw_output=Info2)

```
F;C;mw;fm
mcf_man_soc;1;349.40462;C16H19N3O4S;Ampicillin
mcf_man_soc;2;386.6532;C27H46O;Cholesterol
mcf_exa_soc;3;470.5113;C26H30O8;Limonin
mcf_exa_soc;4;536.8722;C40H56;beta-Carotene
```

(aux_delimiter="/")

```
F:mcf_man_soc/C:1/mw:349.40462/fm:C16H19N3O4S/EN:Ampicillin
F:mcf_man_soc/C:2/mw:386.6532/fm:C27H46O/EN:Cholesterol
F:mcf_exa_soc/C:3/mw:470.5113/fm:C26H30O8/EN:Limonin
F:mcf_exa_soc/C:4/mw:536.8722/fm:C40H56/EN:beta-Carotene
```

(Tag)

```
J  : jobname
C  : char number
NO : serial number
EN : english name
JN : japanese name
FM : formula from literature data
MW : molecular weight from literature data
MI : monoisotopic mass from literature data
USE : the use
mw  : molecular weight calculated
mi  : monoisotopic mass calculated
fm  : molecular formula calculated
w   : font width
h   : font height
```

6.4 Metafont aux file output

(Insert option parameter setting)

```
sw_output:=Mfont;
```

(Command line)

```
>mpost -s ahlengh=7 FILENAME (sw_output=Mfont)
```

(Output)

```
beginfont("Cat:biological","EN:Adenine","MW:135.13",
": <30,?6,3=?5,{1,3,5,9}=d1,{2,6,9}:N,5:/NH2,7:NH")
if check(mc)=0: MC(scantokens(mc)) fi
endfont
beginfont("Cat:biological","EN:Guanine","MW:151.13",
": <30,?6,3=?5,{1,3,9}=d1,{2,9}:N,{6,7}:NH,5://0,1:/NH2")
if check(mc)=0: MC(scantokens(mc)) fi
endfont
beginfont("Cat:biological","EN:Cytosine","MW:111.10",
": <30,?6,{4,6}=d1,4:N,3://0,2:NH,5:/NH2")
if check(mc)=0: MC(scantokens(mc)) fi
endfont
beginfont("Cat:biological","EN:Thymine","MW:126.11",
": <30,?6,3=d1,{2,6}:NH,{1,5}://0,4:/_")
if check(mc)=0: MC(scantokens(mc)) fi
endfont
beginfont("Cat:biological","EN:Adenine","MW:135.13",
": <30,?6,3=?5,{1,3,5,9}=d1,{2,6,9}:N,5:/NH2,7:NH")
if check(mc)=0: MC(scantokens(mc)) fi
endfont
beginfont("Cat:biological","EN:Guanine","MW:151.13",
": <30,?6,3=?5,{1,3,9}=d1,{2,9}:N,{6,7}:NH,5://0,1:/NH2")
if check(mc)=0: MC(scantokens(mc)) fi
endfont
beginfont("Cat:biological","EN:Cytosine","MW:111.10",
": <30,?6,{4,6}=d1,4:N,3://0,2:NH,5:/NH2")
if check(mc)=0: MC(scantokens(mc)) fi
endfont
beginfont("Cat:biological","EN:Thymine","MW:126.11",
": <30,?6,3=d1,{2,6}:NH,{1,5}://0,4:/_")
if check(mc)=0: MC(scantokens(mc)) fi
endfont
beginfont("Cat:biological","EN:Uracil","MW:112.09",
": <30,?6,6=d1,{3,5}://0,{2,4}:NH")
if check(mc)=0: MC(scantokens(mc)) fi
endfont
beginfont("Cat:biological","EN:Geraniol","MW:154.25",
": <30,!8,OH,{2,6}=dr,{2,6}:/_")
if check(mc)=0: MC(scantokens(mc)) fi
endfont
beginfont("Cat:biological","EN:Limonene","MW:136.24",
": <30,?6,2=d1,2:/_,@5,*\,/_,!!")
if check(mc)=0: MC(scantokens(mc)) fi
endfont
beginfont("Cat:biological","EN:l-Menthol","MW:156.27",
": <30,?6,2/*?! ,5*/_ ,3*/OH")
if check(mc)=0: MC(scantokens(mc)) fi
endfont
```

6.5 MCF aux file output(1)

(Insert option parameter setting)

```
sw_output:=Mcode;
```

(Command line)

```
>mpost -s ahlength=8 FILENAME (sw_output=Mcode)
```

(Output)

```
file name = 'mcf_exa_soc-001-Adenine-mc.aux'
```

```
<30,?6,3=?5,{1,3,5,9}=d1,{2,6,9}:N,5:/NH2,7:NH
```

6.6 MCF aux file output(2)

(Insert option parameter setting)

```
beginfont("f:mcf_data_base","t:EN","v:Adenine")
  sw_output:=Mcode_t;
endfont
```

(Lualatex example)

```
%-----
\begin{mplibcode}
  beginfont("f:mcf_data_base","t:EN","v:Vancomycin")
    sw_output:=Mcode_t;    %%% output temp-mc.aux %%%
  endfont;
\end{mplibcode}
%-----
\verbatiminput{temp-mc.aux}
%-----
```

(Output)

```
file name = 'temp-mc.aux'
```

```
<-30,#1,!12,{1,3,12}=zf,7=wf,/H^-60,60,*/OH,60,
Ph,-4:/Cl,@-3,\,0,!,Ph,@-4,\,0,!,Ph,-1^15:/Cl,@-3,\,/*OH,*/H^-60,&1,
@7,&26,@$1,60,//0,60,NH,60,/*H,*/COOH^180,-60,
Ph,{-2,-4}:/OH,@-1,\,Ph,-5:/OH,@-2,&4,##,
{3^40,6,9,12}://0,{2,5,8,11}:NH,{1,4^180}:*/H,{7^-60,10^60,14^60}:/*H,
@10,*\^-60,60,//0,!,NH2,@13,*\,NH,!,//0,!,/??!,*/H^60,!~zf,NH,!,
@23,\,0,!,|,?6'.7,2:0,3^10:!/OH,{4,5}:/OH,
@-1,\,0,!,|,?6'.7,6:0,{3^35,5}:/_,3^-35:/NH2,4:/OH
```

6.7 Report output

(Insert option parameter setting)

```
sw_output:=Report;
```

(Command line)

```
>mpost -s ahlength=3 FILENAME
```

(Output)

```
=====
No.    3 / Name = Cytosine
-----
<30,{?6,{4,6}=d1,4:N,3://0,2:NH,5:/NH2
-----
row= 1 / length= 37 / commands= 7
{}=X = 1 / {}:X = 0 / '() = 0 / @ = 0 / & = 0 / < = 1
-----
Warnings = 0 / Code= 60
Width * Height = 34.68852 * 47.4036
Shift width * height = 0 * -14.46167
Bond length = 12.75589 Atom size = 5.38914
Atom count= 9 Bond count= 9 Ring count= 1 Hide H count= 2
-----
< NO. ><atom(s) >( x axis , y axis )<bond><hideH><chg>
A1 C ( 0 , 0 ) 3 1
A2 N ( 0.866 , -0.5 ) 3
A3 C ( 1.732 , 0 ) 4
A4 N ( 1.732 , 1 ) 3
A5 C ( 0.866 , 1.5 ) 4
A6 C ( 0 , 1 ) 3 1
A7 O ( 2.508 , -0.448 ) 2
A8 H ( 0.866 , -0.922 ) 1
A9 NH2 ( 0.866 , 2.371 ) 1
-----
< NO. >< bond (sdt)><angle +( +- )><length ( pt )>
B1 1 -> 2 ( 1 ) 330 ( -30 ) 1 ( 12.76)
B2 2 -> 3 ( 1 ) 30 ( 30 ) 1 ( 12.76)
B3 3 -> 4 ( 1 ) 90 ( 90 ) 1 ( 12.76)
B4 4 -> 5 ( 2 ) 150 ( 150 ) 1 ( 12.76)
B5 5 -> 6 ( 1 ) 210 ( -150 ) 1 ( 12.76)
B6 6 -> 1 ( 2 ) 270 ( -90 ) 1 ( 12.76)
B7 3 -> 7 ( 2 ) 330 ( -30 ) 0.66 ( 8.42)
B8 2 -> 8 ( 1 ) 270 ( -90 ) 0.36 ( 4.59)
B9 5 -> 9 ( 1 ) 90 ( 90 ) 0.66 ( 8.42)
-----
<atom>( atom wt ) [ mi wt ] < cnt > < sum wt > [ sum mi wt ]
C ( 12.0107 ) [ 12 ] * 4 48.04279 [ 48 ]
H ( 1.00793 ) [ 1.00783 ] * 5 5.03967 [ 5.03914 ]
N ( 14.0067 ) [ 14.00307 ] * 3 42.0201 [ 42.0092 ]
O ( 15.9994 ) [ 15.99492 ] * 1 15.9994 [ 15.99492 ]
Molecular Weight [Mono Isotopic] = 111.1019 [ 111.04326 ]
-----
Weight Calc: 111.1019 / Input: 111.10 / weight gap= 0.00195
Fomula Calc: C4H5N3O / Input:
=====
```

6.8 MOL file output

(Insert option parameter setting)

```
sw_output:=MOL2k;    % MOL(V2000)
sw_output:=MOL3k;    % MOL(V3000)
```

(Command line)

```
>mpost -s ahlength=5 FILENAME    % MOL(V2000)
>mpost -s ahlength=6 FILENAME    % MOL(V3000)
```

(Output)

```
%%%%%%%%%%%%%%%%%%%%%%%%%%%%%%%%%%%%%%%%%%%%%%%%%%%%%%%%%%%%%%%%%%%%%%%%%
```

```
-MCFtoMOL- EN:Caffeine
```

```
14 15 0 0 0 0 0 0 0 0999 V2000
      0      0      0 C  0 0 0 0
  0.86603    -0.5      0 N  0 0 0 0
  1.73206      0      0 C  0 0 0 0
  1.73206      1      0 C  0 0 0 0
  0.86603     1.5      0 C  0 0 0 0
      0      1      0 N  0 0 0 0
  2.6831   -0.30902    0 N  0 0 0 0
  3.27089      0.5      0 C  0 0 0 0
  2.6831    1.30902    0 N  0 0 0 0
  0.86603   -1.36383    0 C  0 0 0 0
 -0.76894    1.44394    0 C  0 0 0 0
 -0.76894   -0.44394    0 D  0 0 0 0
  0.86603    2.36383    0 D  0 0 0 0
  2.95299    2.1396    0 C  0 0 0 0
  1  2  1  0      0  0
  2  3  1  0      0  0
  3  4  2  0      0  0
  4  5  1  0      0  0
  5  6  1  0      0  0
  6  1  1  0      0  0
  3  7  1  0      0  0
  7  8  2  0      0  0
  8  9  1  0      0  0
  9  4  1  0      0  0
  2 10  1  0      0  0
  6 11  1  0      0  0
  1 12  2  0      0  0
  5 13  2  0      0  0
  9 14  1  0      0  0
```

```
M  END
```

```
%%%%%%%%%%%%%%%%%%%%%%%%%%%%%%%%%%%%%%%%%%%%%%%%%%%%%%%%%%%%%%%%%%%%%%%%%
```

6.9 LuaTeX file example

```

\documentclass{article}
\usepackage{luamplib}%
\usepackage[T1]{fontenc}%
\usepackage{textcomp}%
\mplibcodeinherit{enable}%
\mplibverbatim{enable}%
\mplibnumbersystem{double}%
\everymplib{%
  if unknown Ph1: input mcf2graph.mf; fi
  sw_output:=None; sw_fframe:=4; max_blength:=4.5mm;
  defaultfont:="uhvr8r"; defaultsize:=8bp; defaultscale:=1;
}%
\begin{document}
\noindent%
%-----
\begin{mplibcode}
  fsize:=(50mm,50mm);
  beginfont("NO:1","EN:Limonin","MW:470.51",
    %-----
    ": <30,?6,{-3,-4}=?6,           ",
    ": -5=?3,-2=wf,-1=wb,6=?5,-4=?6,-5=wf, ",
    ": {13,15,17,20}:0,{3,12,21}://0,      ",
    ": {4~wf^60,8~zf^60,18^35,18^-35}:/_,  ",
    ": {1^60,5^180,16^60}:/*H,           ",
    ": @14,\*,|,?5,{1,4}=d1,3:0         ")
    %-----
  if check(mc)=0: MC(scantokens(mc)) fi
  endfont
\end{mplibcode}\\
%-----
\begin{mplibcode}
  fsize:=(80mm,50mm);
  beginfont("NO:2","EN:beta-carotene","MW:536.87",
    %-----
    ": <30,?6,3=d1,{3,5^35,5^-35}:/_,      ",
    ": @4,\,|,!18,{1,3,5,7,9,11,13,15,17}=dr, ",
    ": {3,7,12,16}:/_,                      ",
    ": |,?6,6=d1,{6,2^35,2^-35}:/_        ")
    %-----
  if check(mc)=0: MC(scantokens(mc)) fi
  endfont
\end{mplibcode}\\
%-----
\begin{mplibcode}
  fsize:=(50mm,50mm);
  beginfont("NO:3","EN:Gibberellin A3","MW:346.37",
    %-----
    ": <18,?5,3=?7,5=?6[12],              ",
    ": @8,160'1.3,&3,13=d1,6=wf,8=wb,      ",
    ": @5,40~zf'1,0,60,//0^180,&14~zb,    ",
    ": 2:/COOH,7://_,13:*/OH,8:/*OH,      ",
    ": 14:*/_,{1^60,4^60}:*/H             ")
    %-----
  if check(mc)=0: MC(scantokens(mc)) fi
endfont;
%-----
\end{mplibcode}\\
\end{document}

```

6.10 LaTeX file example

```

%-----
\documentclass[a4paper]{article}
\usepackage{graphicx}
\makeatletter%
%-----
\usepackage{mcf_setup}
%-----
\pagestyle{empty}
%-----
\def\put@char{%
  \begin{picture}(84,42)%
    \put(0,38){\bf [MOLnum]\EN{ }\small\tt/FM:\fm/MW:\mw}%
    \put(10,0){\font\@strufont=\File\relax%
      \hbox{\@strufont\char\Char}}%
  \end{picture}%
}%
\def\INFO#1{\@for\@temp:=#1\do{\tag@var\@temp}\put@char}%
\makeatother
%-----
\begin{document}
\unitlength=1mm%
\INFO{J:mcf_man_soc,C:141,NO:1,mw:349.40462,fm:C16H19N3O4S,EN:Ampicillin}%
\INFO{J:mcf_man_soc,C:142,NO:2,mw:386.6532,fm:C27H46O,EN:Cholesterol}%
\end{document}
%-----

```

[1]Ampicillin

FM:C16H19N3O4S MW:349.40462

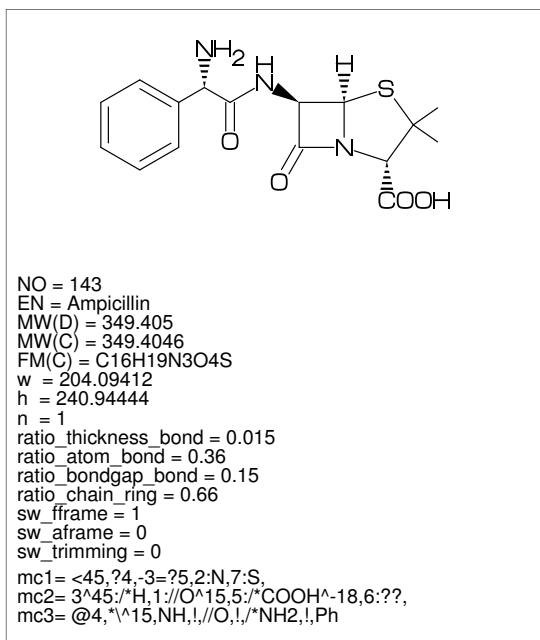

[2]Cholesterol

FM:C27H46O MW:386.6532

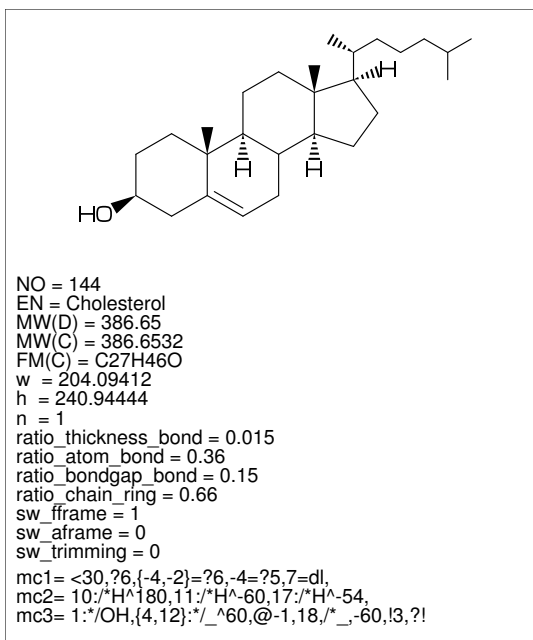

Index

!, 3
!!, 4
!!!, 4
, 7
**, 6, 12
*/, 6
/, 6
*\, 3
**, 3
/, 6
/*, 6, 12
//, 6
:, 5
?, 3
?!, 7
??, 7
??!, 7
@, 3
@(), 7
#, 4
##, 4
\$, 5
&, 3
~, 3, 6
~, 3, 4, 6
~~, 4
\, 3
*, 3
\\, 3
|, 5
||, 5
>, 3, 7
>>, 12
<, 6
' , 3, 4, 6

A[], 12
A[]ang, 12
A[]down, 12
A[]left, 12
A[]right, 12
A[]up, 12
add(), 12
An, 12
atomfont, 8
aux_delimiter, 17
aw, 12, 13

B[], 12
B[]ang, 12
B[]down, 12
B[]e, 12
B[]left, 12
B[]m, 12
B[]right, 12
B[]s, 12
B[]up, 12
bd, 4

bd_, 4
beginfont(), 11
blength, 8
blue, 8
Bn, 12
bz, 4

C, 17
check(), 11, 14
circlediam, 12
circlepen, 12

db, 4
defaultscale, 12, 13
dl, 4
dl_, 4
dm, 4
dm_, 4
dr, 4
dr_, 4
dt, 4

em, 12, 13
EN, 17
endfont, 11
ext(), 13
ext_clear, 13

FM, 17
fm, 17
fmargin, 9
fsize, 9

green, 8

h, 12, 17
h0, 13
hz, 7

Info1, 17
Info2, 17
Info_t, 17

J, 17
JN, 17

l, 12
labeloffset, 12
lonepair, 12
lonepairdiam, 12
lonepairspace, 12
lr, 7

mangle, 8
max_blength, 9
MC(), 11
MCat(), 11
mcf2graph.mf, 15
mcf_setup.sty, 23

Mcode, 19
Mcode_t, 19
Mfont, 18
MI, 17
mi, 17
minus, 12
MOL2k, 21
MOL3k, 21
mposition, 8
msize, 8
MW, 17
mw, 17

n, 13
N!, 7
N!2, 7
N?!, 7
NH, 7
NO, 17
None, 22
numberA, 10
numberA_end, 10
numberA_start, 10
numberB, 10
numberB_end, 10
numberB_start, 10

offset_atom, 9
offset_bond_gap, 9
offset_thickness, 9
offset_wedge, 9

p0, 12
Ph, 6
plus, 12

ratio_atom_bond, 9
ratio_atomgap_atom, 9
ratio_bondgap_bond, 9
ratio_chain_ring, 9
ratio_char_bond, 9
ratio_hashgap_bond, 9
ratio_thickness_bond, 9
ratio_thickness_char, 13
ratio_wedge_bond, 9
red, 8
Report, 20
rl, 7

si_, 4
S0, 7
S00, 7
sw_aframe, 10
sw_expand, 10
sw_fframe, 10
sw_group_off, 10
sw_mframe, 10
sw_output, 15, 20, 21
sw_single, 10
sw_trimming, 10

tag, 15
tm, 4

USE, 17

var, 15
vb, 4
vf, 4
vt, 7

w, 12, 17
w0, 13
wb, 4
wb_, 4
wf, 4
wf_, 4
wv, 4

zb, 4
zb_, 4
zf, 4
zf_, 4